

Write your name here

Surname

Other names

Pearson
Edexcel GCSE

Centre Number

--	--	--	--	--

Candidate Number

--	--	--	--

Mathematics A

Paper 2 (Calculator)

Higher Tier

Friday 8 November 2013 – Morning

Time: 1 hour 45 minutes

Paper Reference

1MA0/2H

You must have: Ruler graduated in centimetres and millimetres, protractor, pair of compasses, pen, HB pencil, eraser, calculator. Tracing paper may be used.

Total Marks

Instructions

- Use **black** ink or ball-point pen.
- **Fill in the boxes** at the top of this page with your name, centre number and candidate number.
- Answer **all** questions.
- Answer the questions in the spaces provided – *there may be more space than you need.*
- **Calculators may be used.**
- If your calculator does not have a π button, take the value of π to be 3.142 unless the question instructs otherwise.



Information

- The total mark for this paper is 100
- The marks for **each** question are shown in brackets – *use this as a guide as to how much time to spend on each question.*
- Questions labelled with an **asterisk** (*) are ones where the quality of your written communication will be assessed.

Advice

- Read each question carefully before you start to answer it.
- Keep an eye on the time.
- Try to answer every question.
- Check your answers if you have time at the end.

Turn over ►

P44024A

©2013 Pearson Education Ltd.

5/4/5/5/



PEARSON

GCSE Mathematics 1MA0

Formulae: Higher Tier

**You must not write on this formulae page.
Anything you write on this formulae page will gain NO credit.**

Volume of prism = area of cross section \times length

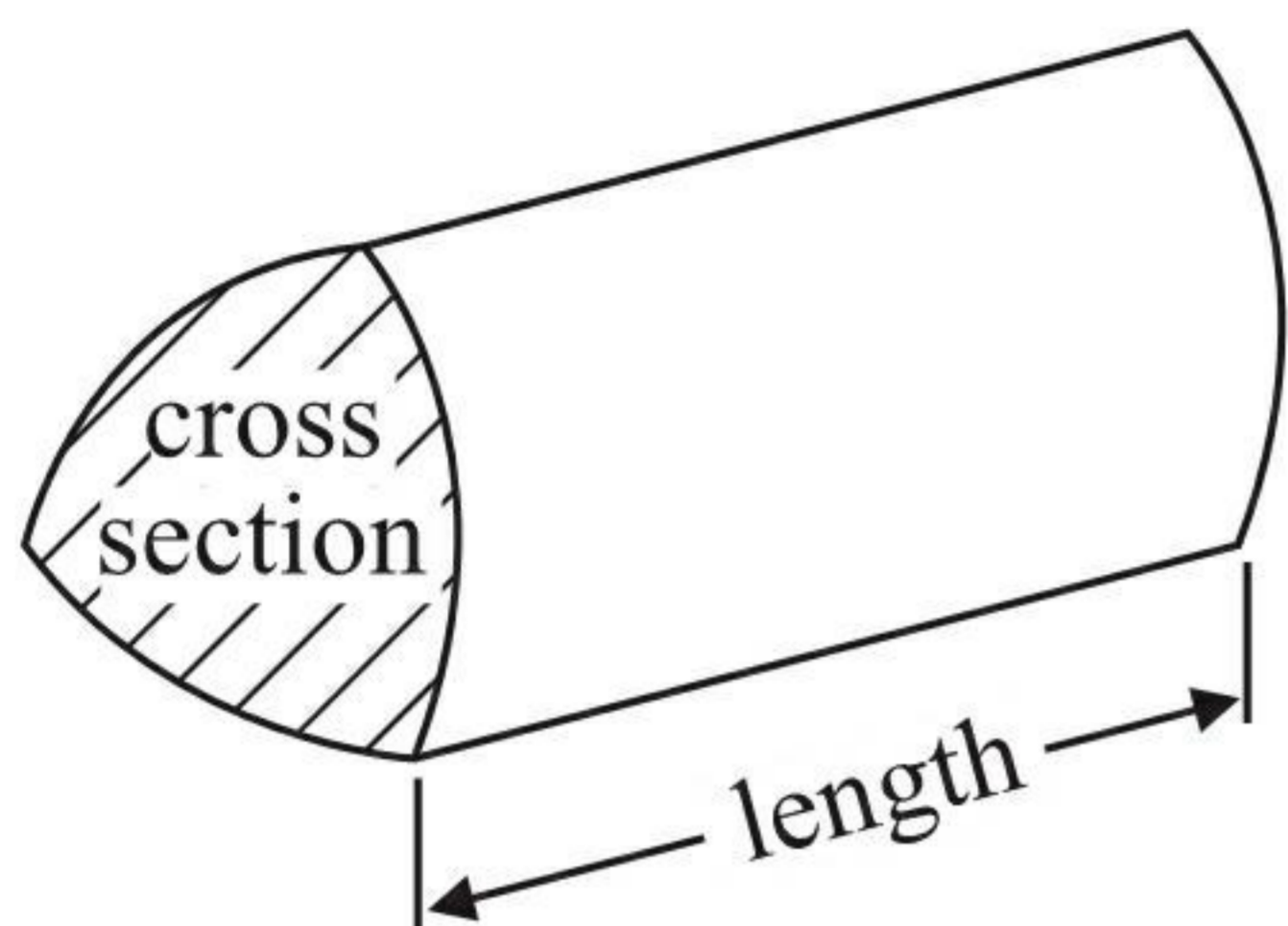

Area of trapezium = $\frac{1}{2} (a + b)h$

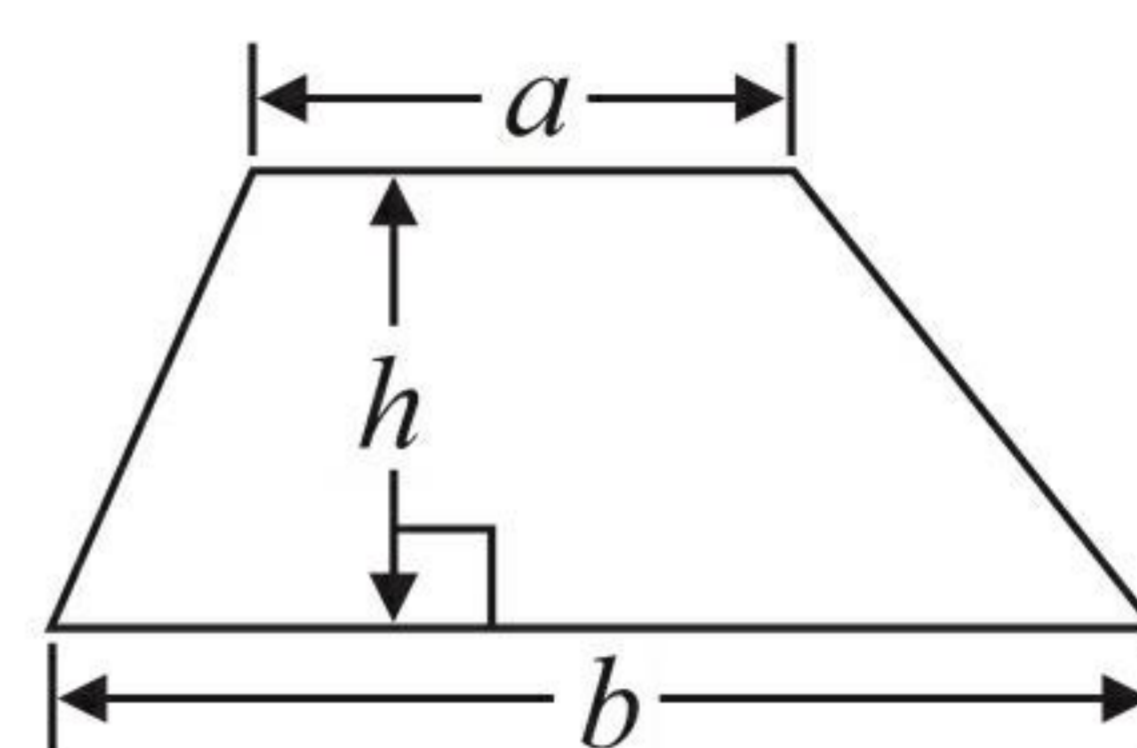

Volume of sphere = $\frac{4}{3} \pi r^3$

Surface area of sphere = $4\pi r^2$

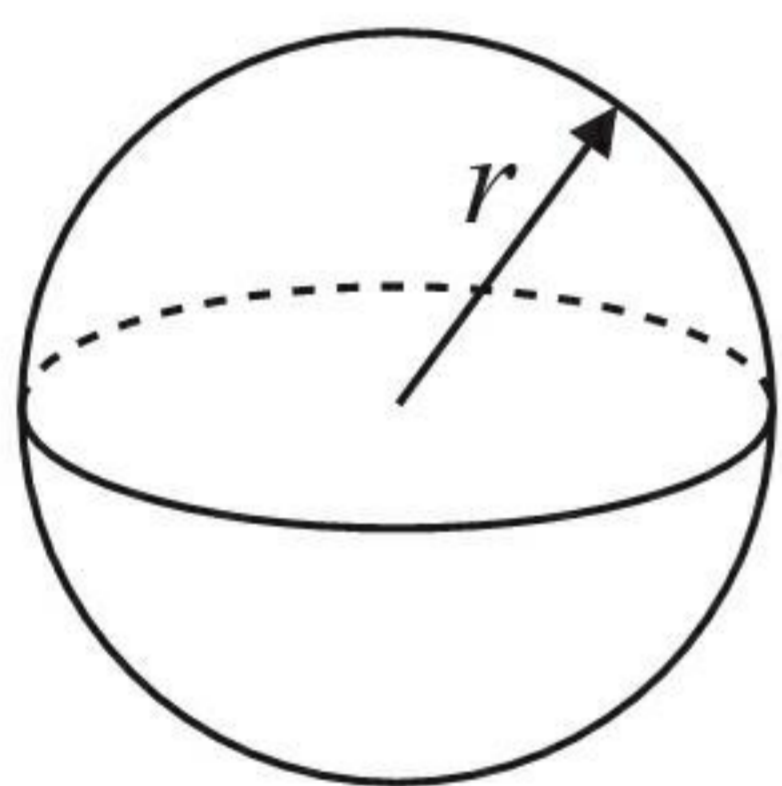

Volume of cone = $\frac{1}{3} \pi r^2 h$

Curved surface area of cone = $\pi r l$

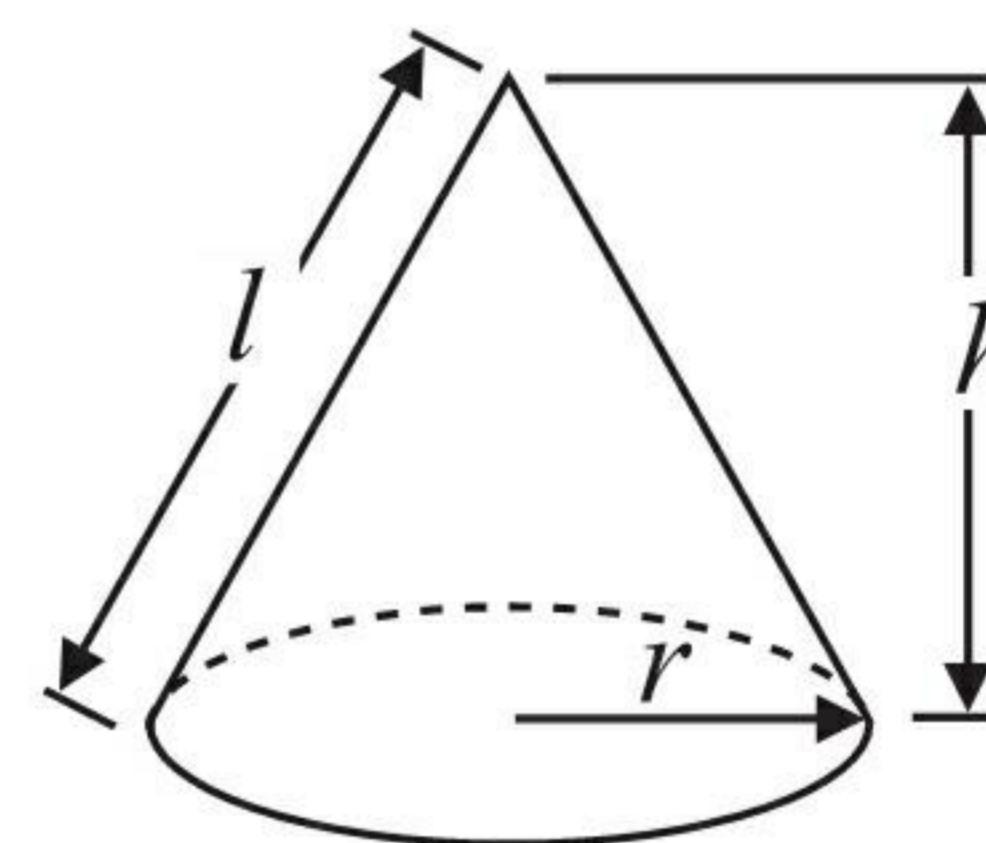

In any triangle ABC

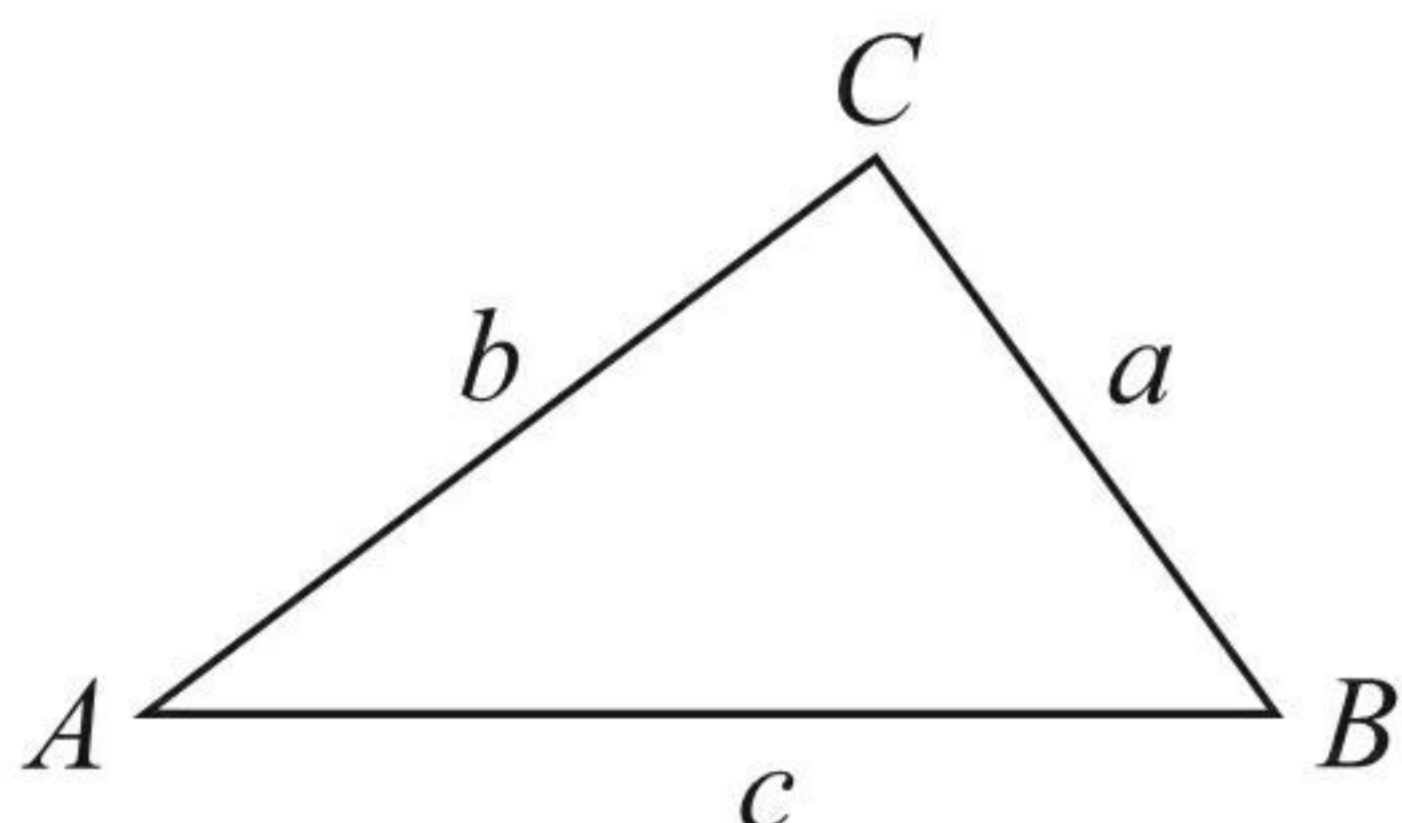

The Quadratic Equation

The solutions of $ax^2 + bx + c = 0$
where $a \neq 0$, are given by

$$x = \frac{-b \pm \sqrt{b^2 - 4ac}}{2a}$$

Sine Rule $\frac{a}{\sin A} = \frac{b}{\sin B} = \frac{c}{\sin C}$

Cosine Rule $a^2 = b^2 + c^2 - 2bc \cos A$

Area of triangle = $\frac{1}{2} ab \sin C$



Answer ALL questions.

Write your answers in the spaces provided.

You must write down all stages in your working.

1 (a) Use your calculator to work out $\frac{\sqrt{7056}}{0.35 \times 12.8}$

Write down all the figures on your calculator display.
You must give your answer as a decimal.

18.75
.....
(2)

(b) Write your answer to part (a) correct to 1 significant figure.

20
.....
(1)

(Total for Question 1 is 3 marks)

2 Pavel and Katie share some sweets in the ratio 3 : 8
Katie gets 32 sweets.

12:32

(a) How many sweets does Pavel get?

12
.....
(2)

Katie also has a tin of chocolates.
There are 80 chocolates in the tin.
45% of the chocolates have toffee in the middle.

(b) Work out the number of chocolates that have toffee in the middle.

$$\begin{aligned} 50\% &= 40 \\ 5\% &= 4 \\ 45\% &= 36 \end{aligned}$$

36
.....
(2)

(Total for Question 2 is 4 marks)



3 Bill has some counters in a bag.

3 of the counters are red. } 10
7 of the counters are blue. }
The rest of the counters are yellow.

Bill takes at random a counter from the bag.

The probability that he takes a yellow counter is $\frac{2}{7}$

How many yellow counters are in the bag before Bill takes a counter?

$$\frac{5}{7} \text{ is } 10$$
$$\frac{1}{7} \text{ is } 2$$
$$\frac{2}{7} \text{ is } 4$$

4

(Total for Question 3 is 2 marks)



4 The diagram shows a solid prism.

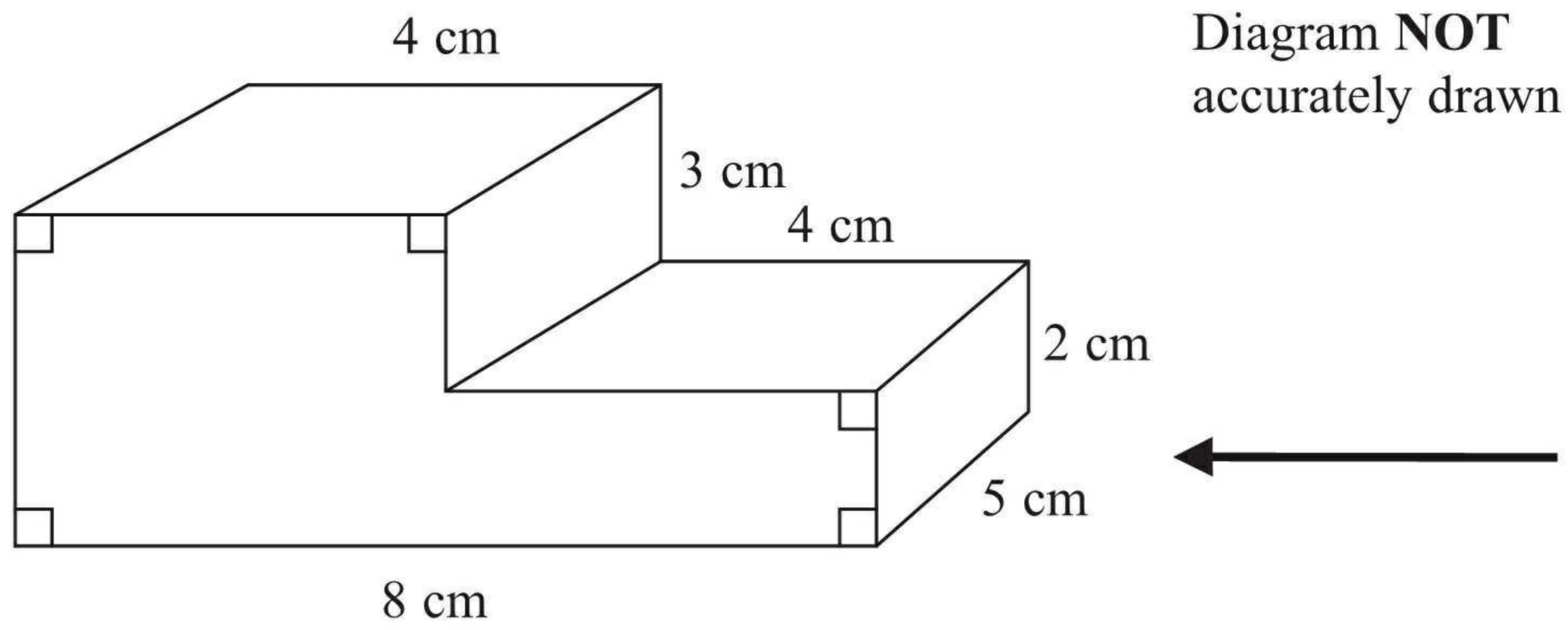

On the centimetre square grid, draw the side elevation of the solid prism from the direction shown by the arrow.

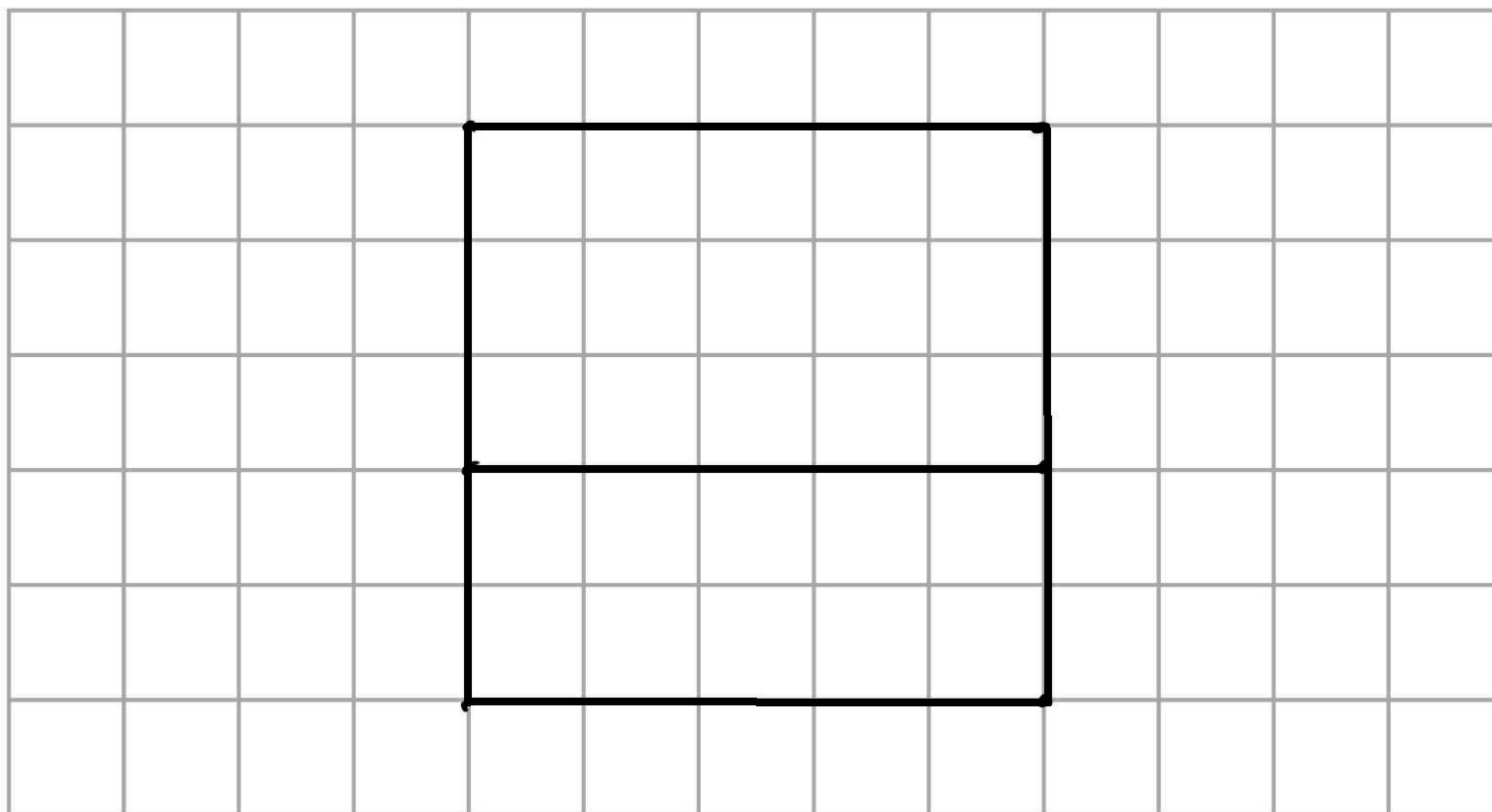

(Total for Question 4 is 2 marks)



5 Ben goes on holiday to Hong Kong.

In Hong Kong, Ben sees a camera costing HK\$3179.55

In London, an identical camera costs £285

The exchange rate is £1 = HK\$12.30

Ben buys the camera in Hong Kong.

How much cheaper is the camera in Hong Kong than in London?

In Hong Kong :

$$3179.55 \div 12.30 = £258.50$$

$$285 - 258.5 = £26.50$$

£26.50

(Total for Question 5 is 3 marks)



- 6 There are 130 adults at a language school.
Each adult studies one of French or Spanish or German.

96 of the adults are women.
12 of the women study French.
73 of the adults study Spanish.
55 of the women study Spanish.
9 of the men study German.

How many of the adults study French?

	Men	Women	Total
French	7	12	19
Spanish	18	55	73
German	9	29	38
Total	34	96	130

19

(Total for Question 6 is 4 marks)



*7 Plants are sold in three different sizes of tray.

A small tray of 30 plants costs £6.50

A medium tray of 40 plants costs £8.95

A large tray of 50 plants costs £10.99

Kaz wants to buy the tray of plants that is the best value for money.

Which size tray of plants should she buy?

You must show all your working.

Cost per plant :

$$\text{small tray } \frac{\pounds 6.50}{30} = 0.21\dot{6}$$

$$\text{medium tray } \frac{\pounds 8.95}{40} = 0.22375$$

$$\text{Large tray } \frac{\pounds 10.99}{50} = 0.2198$$

The small tray is better value.

(Total for Question 7 is 4 marks)



8 Here are the first four terms of an arithmetic sequence.

3

10

17

24

(a) Find, in terms of n , an expression for the n th term of this arithmetic sequence.

$$\underline{7n - 4}$$

(2)

(b) Is 150 a term of this sequence?

You must explain how you get your answer.

150 is a term of the sequence.

If you add 4, then divide by seven
you get a whole number. 150 is the
22nd term in the sequence.

(2)

(Total for Question 8 is 4 marks)



9 The diagram shows a pattern using four identical rhombuses.

Diagram NOT accurately drawn

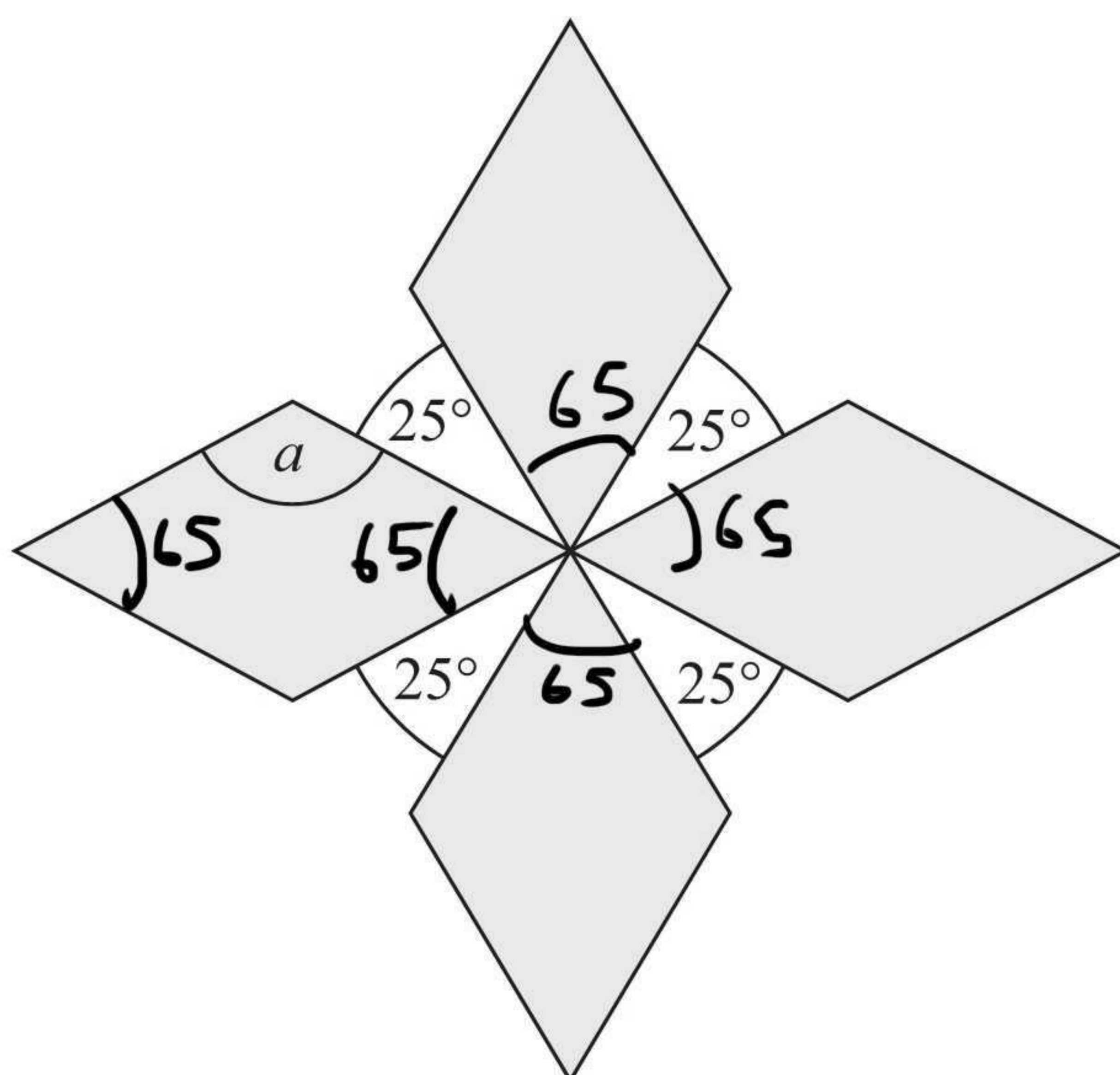

Work out the size of the angle marked a .
You must show your working.

$$360 - 100 = 260$$

Angles in circle = 360°

$$\frac{260}{4} = 65^\circ$$

$$360 - (2 \times 65) = 230$$

Angles in quadrilateral equal 360°

$$\frac{230}{2} = 115^\circ$$

opposite angles in rhombus are equal

115 $^\circ$

(Total for Question 9 is 4 marks)



10 Sasha takes a music exam.

The table shows the result that Sasha can get for different percentages in her music exam.

Percentage	Result
50% – 69%	Pass
70% – 84%	Merit
85% – 100%	Distinction

Sasha gets 62 out of 80 in her music exam.

What result does Sasha get?

You must show your working.

$$\frac{62}{80} \times 100 = 77.5\%$$

Merit

(Total for Question 10 is 3 marks)

11 (a) Simplify $x^7 \times x^3$

$$x^{10}$$

(1)

(b) Simplify $(m^4)^3$

$$m^{12}$$

(1)

(c) Simplify $\frac{36af^8}{12a^5f^2}$

$$3a^{-4}f^6$$

(2)

(Total for Question 11 is 4 marks)



12 A circle has a diameter of 140 cm.

Work out the circumference of the circle.

Give your answer correct to 3 significant figures.

$$\begin{aligned} & 2 \times \pi \times r \\ &= 2 \times \pi \times 70 \\ &= 439.8229715 \end{aligned}$$

440 cm

(Total for Question 12 is 2 marks)



*13 Axel and Lethna are driving along a motorway.

They see a road sign.

The road sign shows the distance to Junction 8

It also shows the average time drivers will take to get to Junction 8

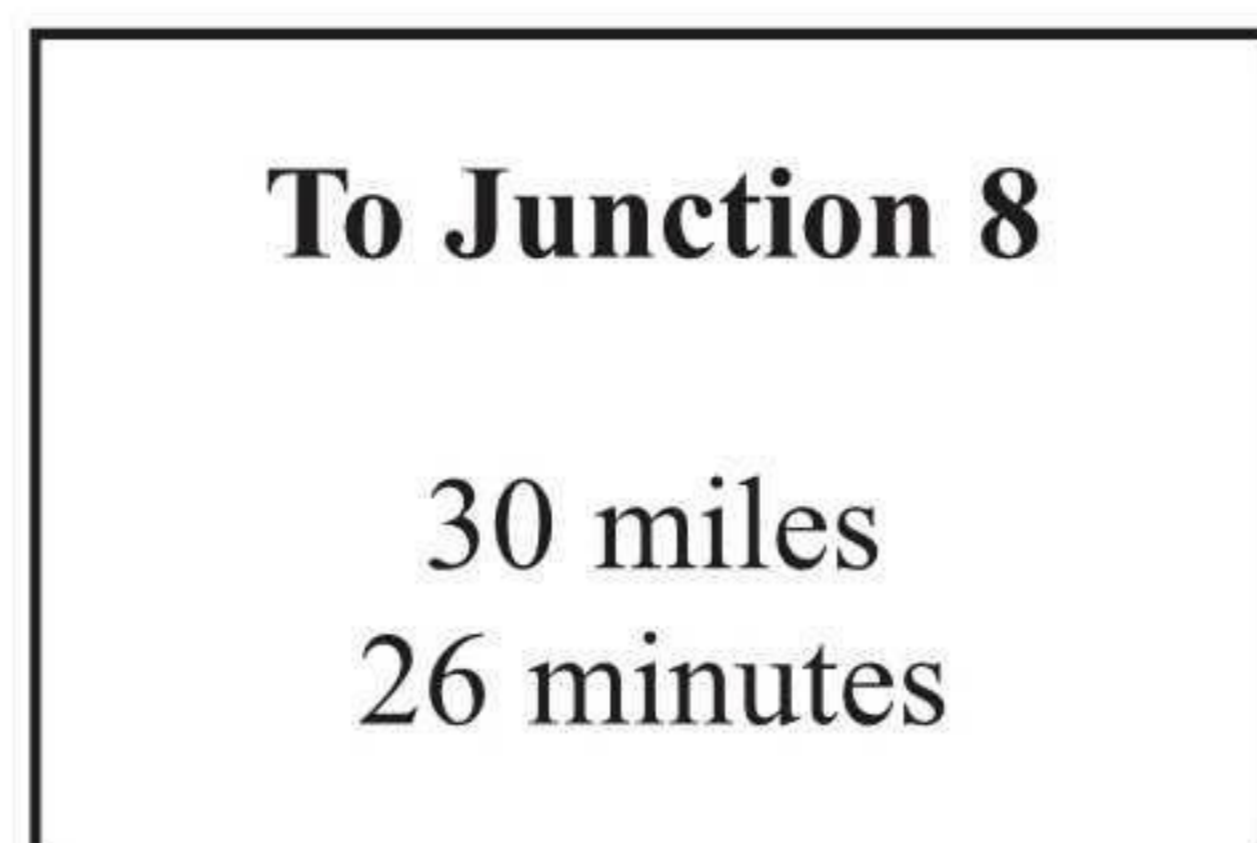

The speed limit on the motorway is 70 mph.

Lethna says,

‘We will have to drive faster than the speed limit to go 30 miles in 26 minutes.’

Is Lethna right?

You must show how you got your answer.

30 miles in 26 mins

÷ 26

$\frac{15}{13}$ miles in 1 min

× 60

69.2 miles in 1 hour

Lethna is wrong, it is not over 70 mph.

(Total for Question 13 is 3 marks)



14 The table gives information about the temperature, T °C, at noon in a town for 50 days.

Temperature (T °C)	Frequency
$8 < T \leq 12$	6
$12 < T \leq 16$	8
$16 < T \leq 20$	13
$20 < T \leq 24$	21
$24 < T \leq 28$	2

60
 112
 234
 462
 52

 920

(a) Write down the modal class interval.

$20 < T \leq 24$
(1)

(b) Calculate an estimate for the mean temperature.

$$920 \div 50$$

18.4 °C
(4)



(c) Draw a frequency polygon for the information in the table.

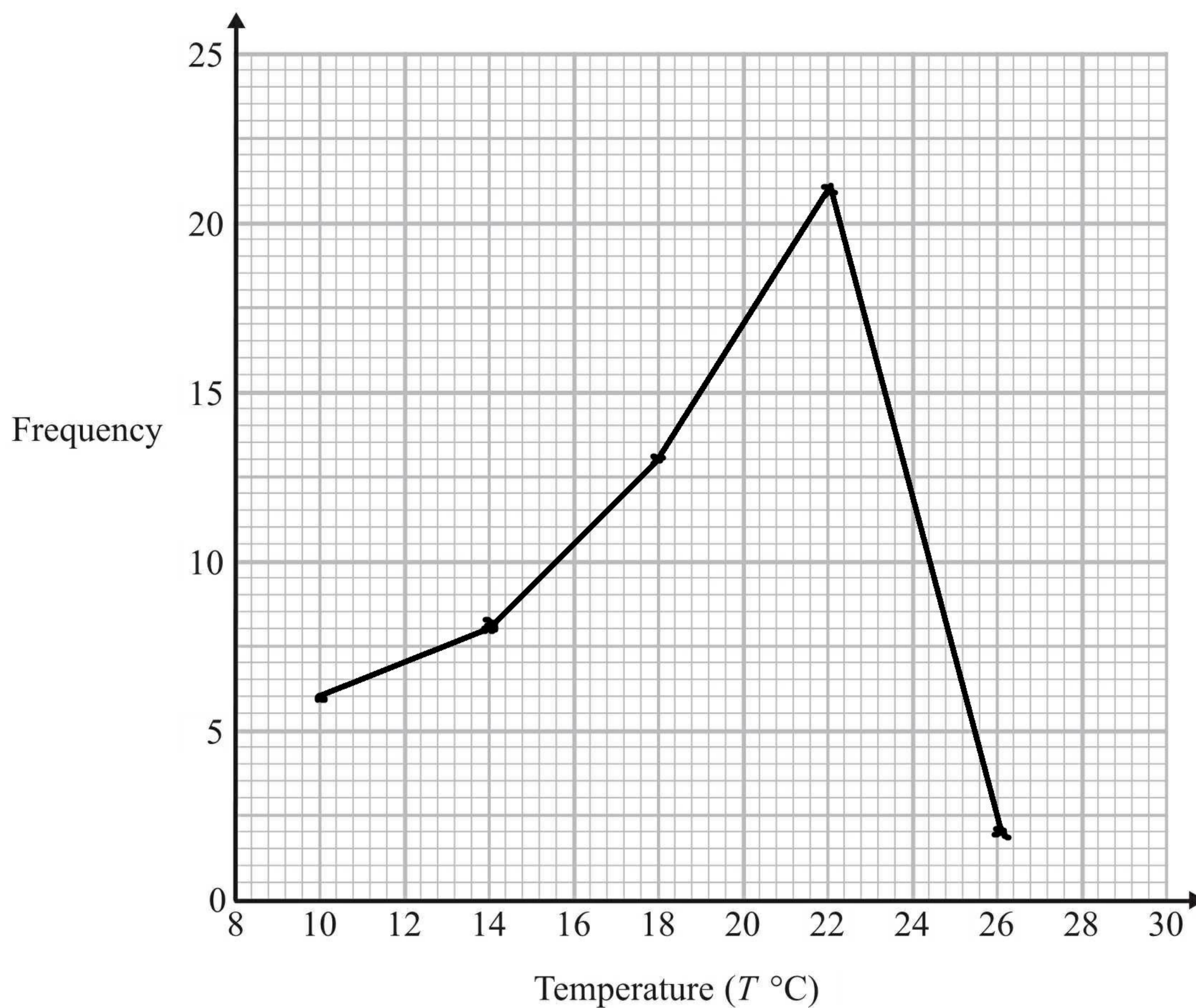

(2)

(Total for Question 14 is 7 marks)



15 Here is a right-angled triangle.

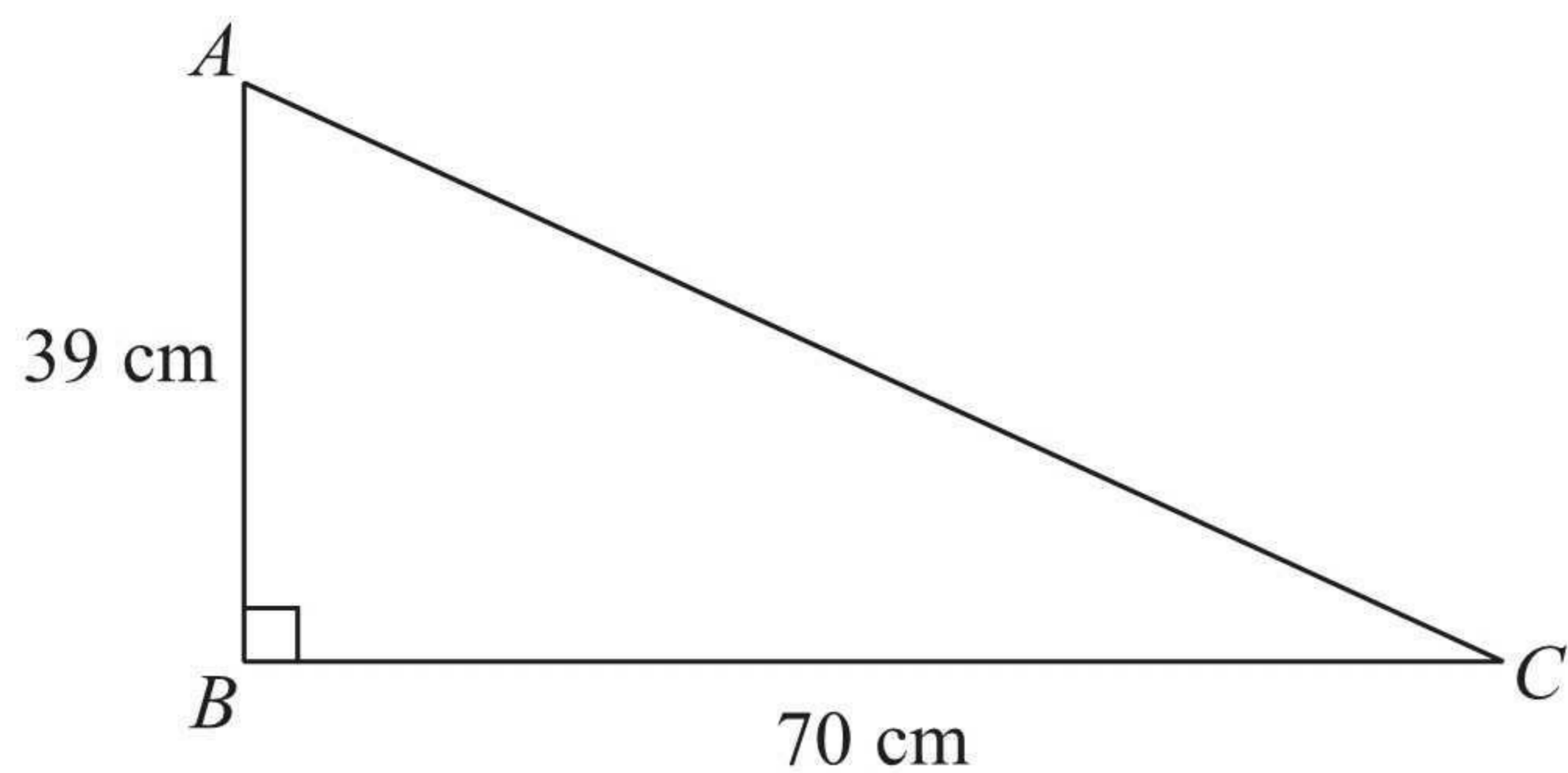

Diagram **NOT**
accurately drawn

Work out the length of AC .

Give your answer correct to 1 decimal place.

$$39^2 + 70^2 = x^2$$

$$6421 = x^2$$

$$\sqrt{6421} = x$$

$$x = 80.1 \text{ (1dp)}$$

.....80.1..... cm

(Total for Question 15 is 3 marks)



16 (a) Solve $5(f-3) = f+10$

$$5f-15 = f+10$$

$$4f-15 = 10$$

$$4f = 25$$

$$f = 6.25$$

$$\underline{f = 6.25}$$

(3)

(b) Solve $\frac{h+7}{3} + \frac{2h-1}{2} = \frac{5}{6}$

$$\frac{2(h+7)}{6} + \frac{3(2h-1)}{6} = \frac{5}{6}$$

$$\frac{2h+14+6h-3}{6} = \frac{5}{6}$$

$$2h+14+6h-3 = 5$$

$$8h+11 = 5$$

$$8h = -6$$

$$h = \frac{-6}{8}$$

$$\underline{-0.75}$$

(4)

(Total for Question 16 is 7 marks)



17 (a) Complete the table of values for $y = x^3 - 4x$

x	-3	-2	-1	0	1	2	3
y	-15	0	3	0	-3	0	15

(2)

(b) On the grid, draw the graph of $y = x^3 - 4x$ from $x = -3$ to $x = 3$

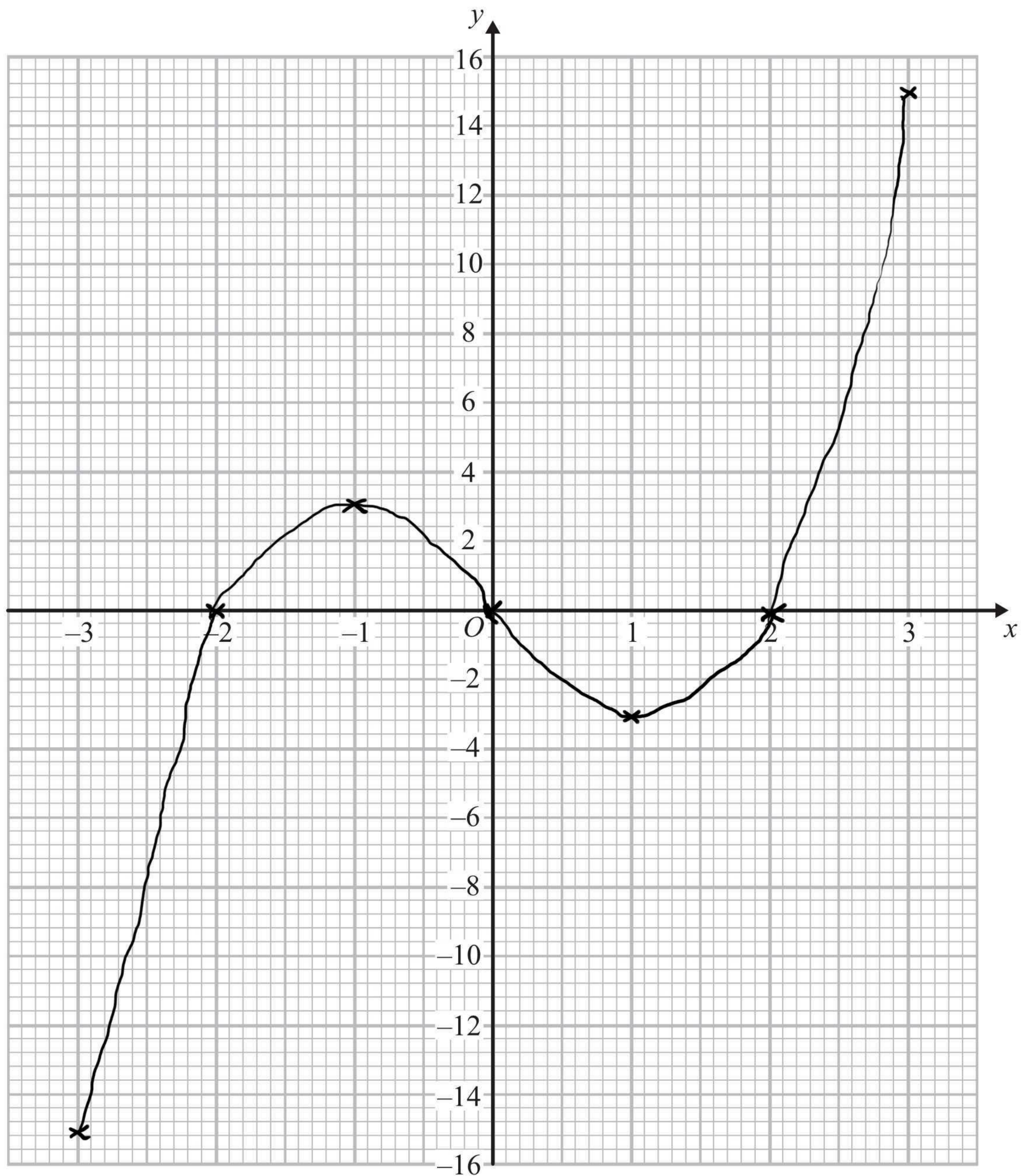

(2)

(Total for Question 17 is 4 marks)



18 ABC is an isosceles triangle.

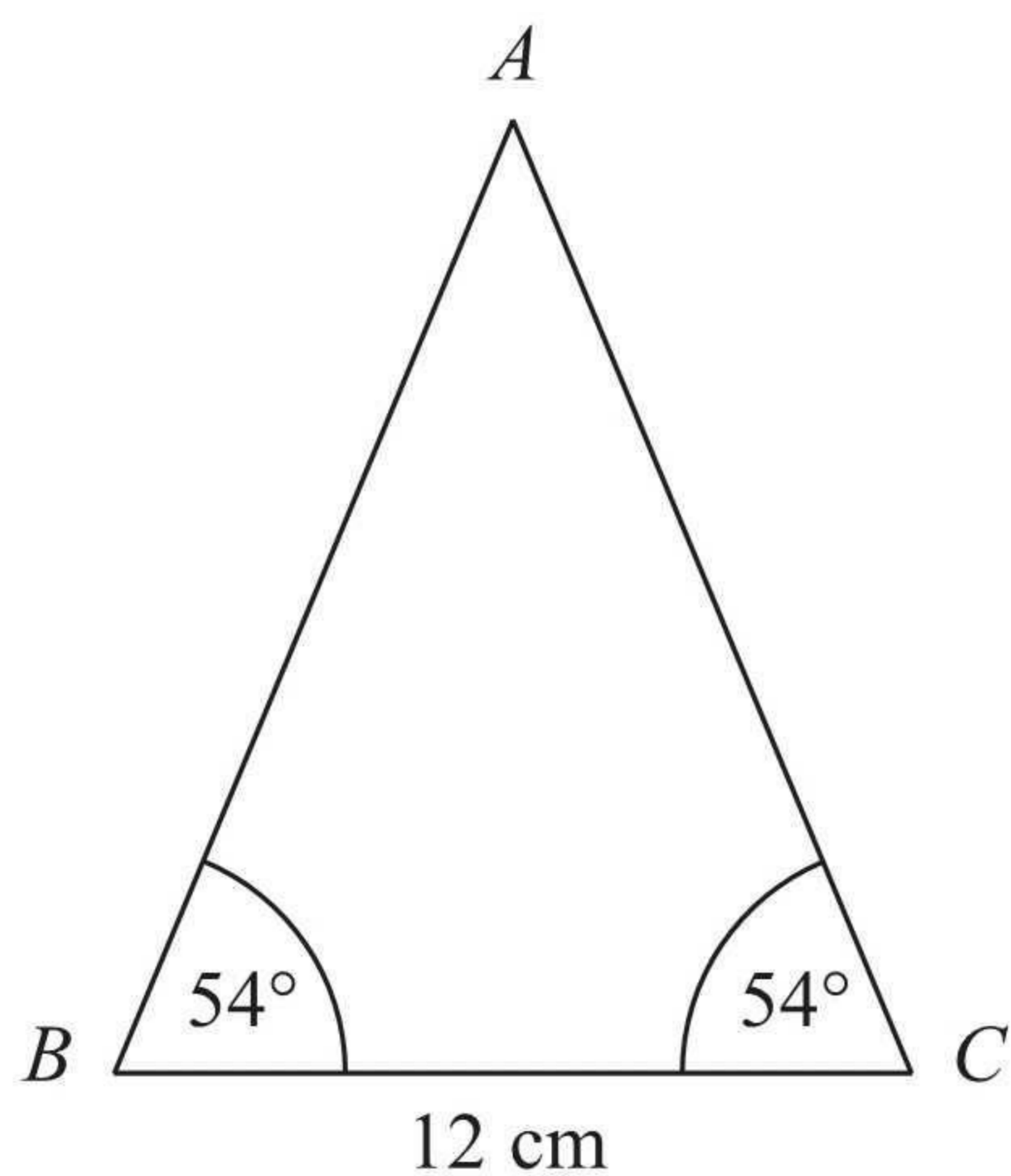
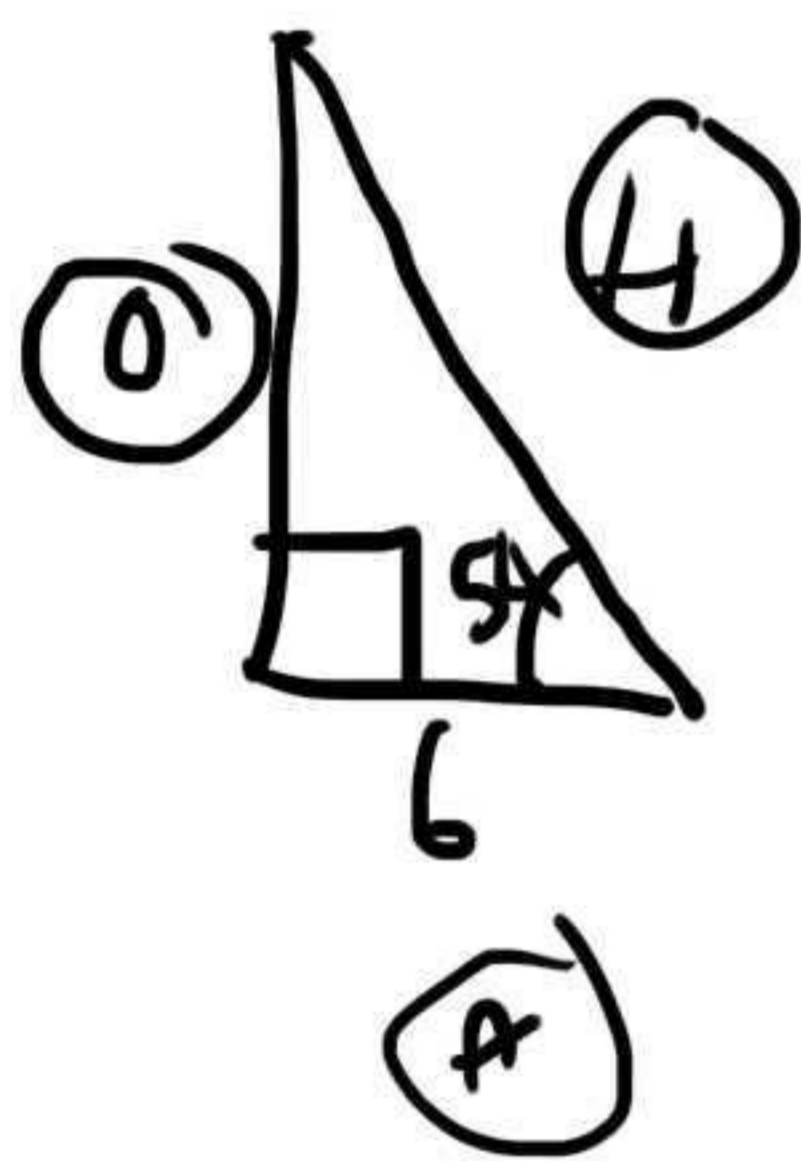

Diagram **NOT** accurately drawn

Work out the area of the triangle.
Give your answer correct to 3 significant figures.



$$\tan(54) = \frac{x}{6}$$

$$x = 6 \tan(54)$$

$$x = 8.258\dots$$

$$\begin{aligned} \text{Area} &= \frac{1}{2} \times 12 \times \text{ANS} \\ &= 49.5 \text{ cm}^2 \quad (\text{3sf}) \end{aligned}$$

49.5 cm²

(Total for Question 18 is 4 marks)



19 (a) Write 7.8×10^{-4} as an ordinary number.

0.00078
(1)

(b) Write 95 600 000 as a number in standard form.

9.56×10^7
(1)

(Total for Question 19 is 2 marks)

20 In a sale normal prices are reduced by 20%.

A washing machine has a sale price of £464

By how much money is the normal price of the washing machine reduced?

$$\begin{aligned}£464 &= 80\% \\£580 &= 100\% \\£580 &= 100\%\end{aligned}$$

£ 580

(Total for Question 20 is 3 marks)



21 (a) Factorise $4x^2 - 9$

$$\frac{(2x+3)(2x-3)}{(1)}$$

(b) Make m the subject of

$$g - 3m = am + 5$$

$$g = am + 3m + 5$$

$$g - 5 = am + 3m$$

$$g - 5 = m(a + 3)$$

$$\frac{g - 5}{a + 3} = m$$

$$\frac{m = \frac{g - 5}{a + 3}}{(3)}$$

(Total for Question 21 is 4 marks)



22 The diagram shows a trapezium.

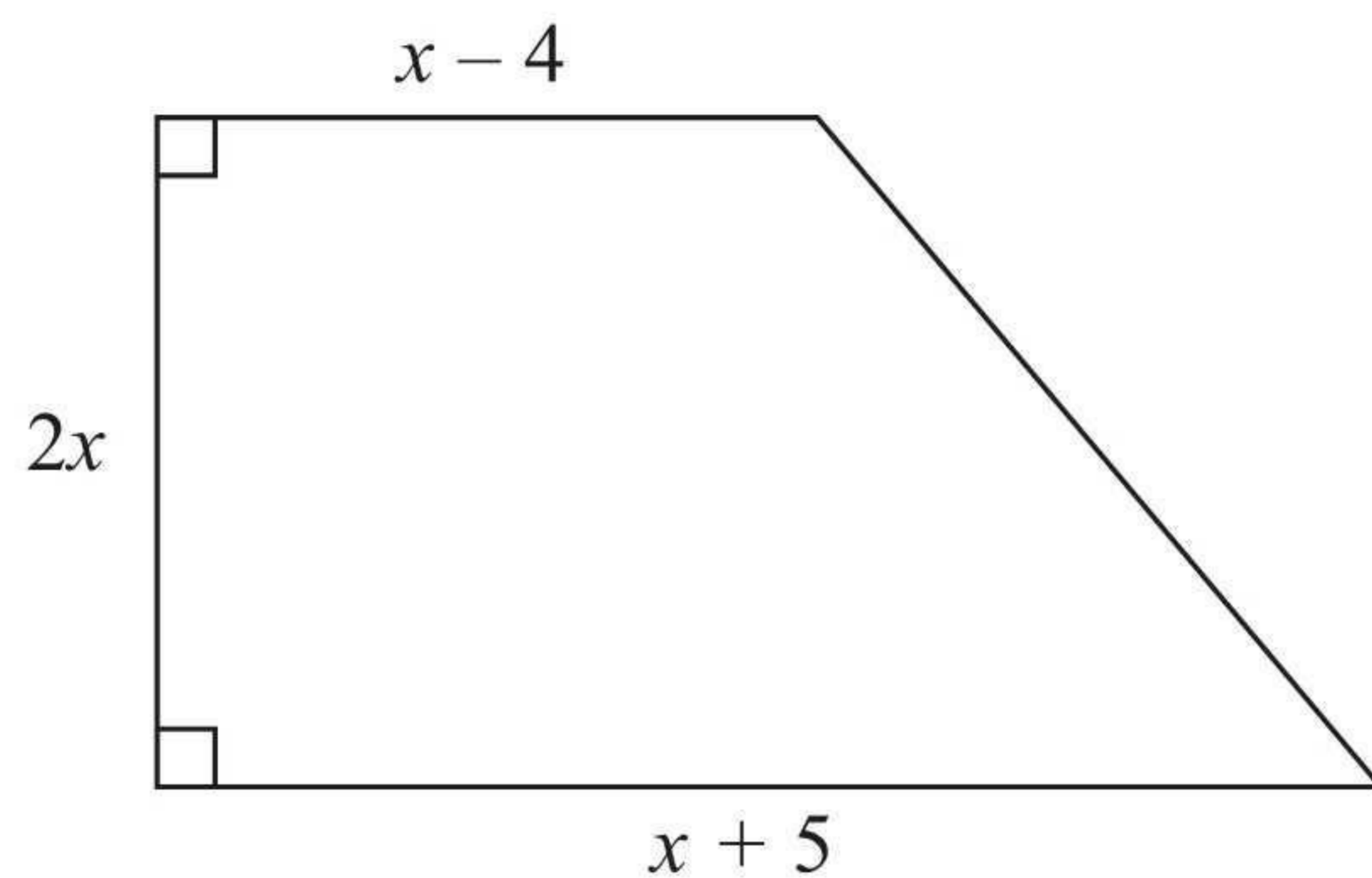

Diagram NOT accurately drawn

All the measurements are in centimetres.

The area of the trapezium is 351 cm^2 .

(a) Show that $2x^2 + x - 351 = 0$

$$\text{Area} = \frac{x+5 + x-4}{2} \times 2x$$

$$351 = \left(\frac{2x+1}{2} \right) 2x$$

$$351 = \frac{4x^2 + 2x}{2} \quad (2)$$

(b) Work out the value of x .

$$0 = 2x^2 + x - 351$$

$$(2x + 27)(x - 13) = 0$$

$$x = -\frac{27}{2} \quad x = 13$$

x cannot be negative

$$\therefore x = 13 \text{ cm}$$

13

(3)

(Total for Question 22 is 5 marks)



23 The table shows information about 1065 students.

	Male	Female
Year 7	126	109
Year 8	112	134
Year 9	121	114
Year 10	87	94
Year 11	88	80

Elena takes a stratified sample of 120 students by year group and by gender.

Work out the number of Year 8 female students in her sample.

$$\frac{134}{1065} \times 120$$

.....15

(Total for Question 23 is 2 marks)



24 The diagram shows a large tin of pet food in the shape of a cylinder.

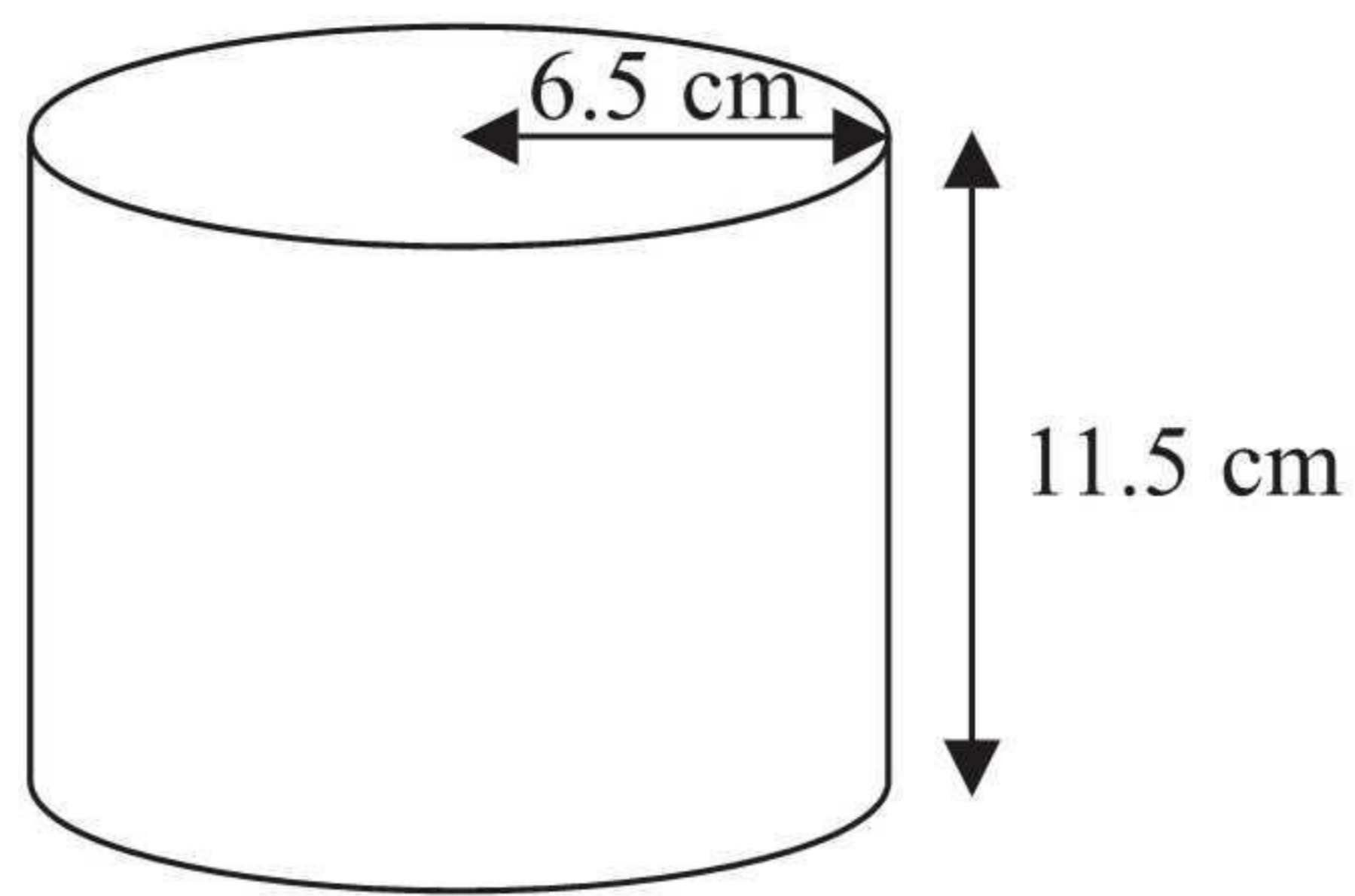

Diagram NOT
accurately drawn

The large tin has a radius of 6.5 cm and a height of 11.5 cm.

A pet food company wants to make a new size of tin.

The new tin will have a radius of 5.8 cm.

It will have the same volume as the large tin.

Calculate the height of the new tin.

Give your answer correct to one decimal place.

$$\begin{aligned} \text{volume} &= \pi \times 6.5^2 \times 11.5 \\ &= 1526.421331 \end{aligned}$$

$$1526.421331 = \pi \times 5.8^2 \times h$$

$$\frac{\text{ANS}}{5.8^2 \times \pi} = h$$

$$h = 14.4 \text{ cm (1dp)}$$

14.4 cm

(Total for Question 24 is 3 marks)



*25 A and B are straight lines.

Line A has equation $2y = 3x + 8$

Line B goes through the points $(-1, 2)$ and $(2, 8)$

Do lines A and B intersect?

You must show all your working.

$$\text{Gradient of line B} = \frac{8-2}{2-(-1)} = \frac{6}{3} = 2$$

$$\text{Gradient of line A} = 1.5$$

(using $y = mx + c$)

$$2y = 3x + 8$$
$$y = \underline{1.5x} + 4$$

The two lines have different gradients,
therefore they intersect.

(Total for Question 25 is 3 marks)



26 The diagram shows triangle LMN .

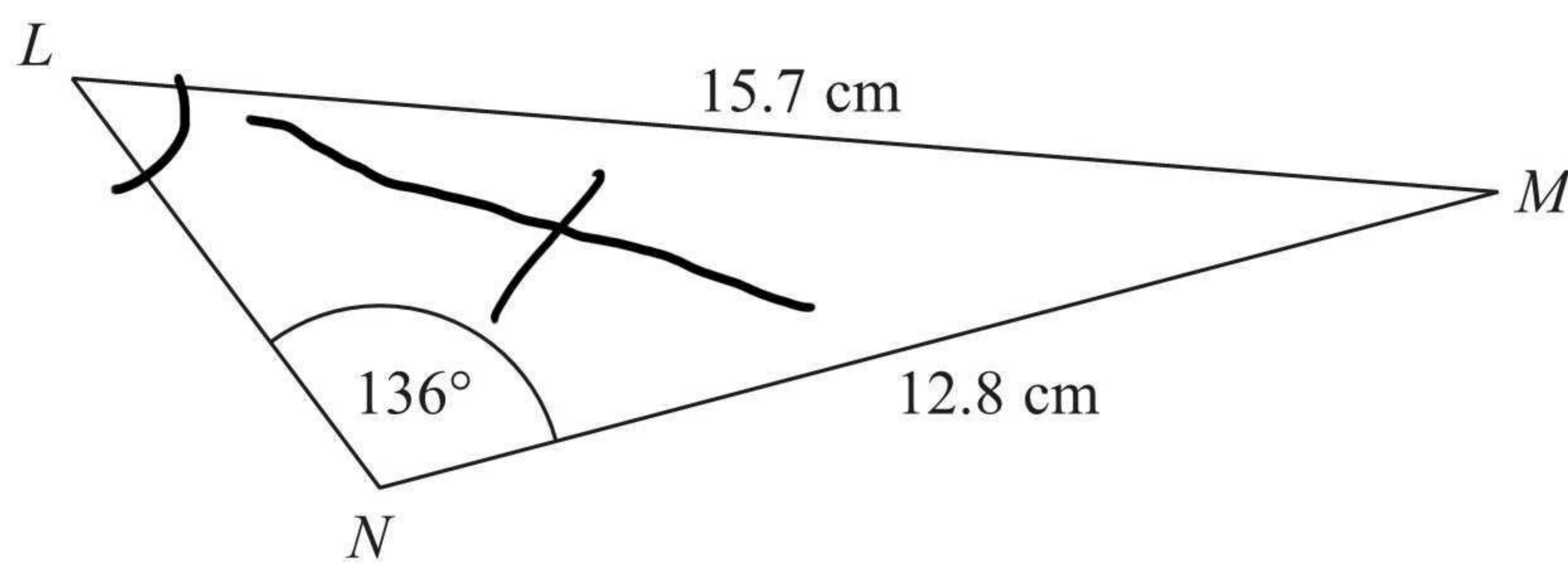

Diagram NOT
accurately drawn

Calculate the length of LN .

Give your answer correct to 3 significant figures.

$$\frac{\sin(L)}{12.8} = \frac{\sin(136)}{15.7}$$

$$\sin(L) = \frac{\sin(136)}{15.7} \times 12.8$$

$$\sin(L) = 0.566 \dots$$

$$L = 34.49578985^\circ$$

$$\begin{aligned} \text{Angle } M &= 180 - \text{ANS} - 136 \\ &= 9.504210148^\circ \end{aligned}$$

$$\frac{x}{\sin(\text{ANS})} = \frac{15.7}{\sin(136)}$$

$$x = \frac{15.7}{\sin(136)} \times \sin(\text{ANS})$$

$$= 3.73 \text{ cm (3sf)} \quad \underline{\underline{3.73}} \text{ cm}$$

(Total for Question 26 is 5 marks)



27 The histogram shows information about the times, in minutes, that some passengers had to wait at an airport.

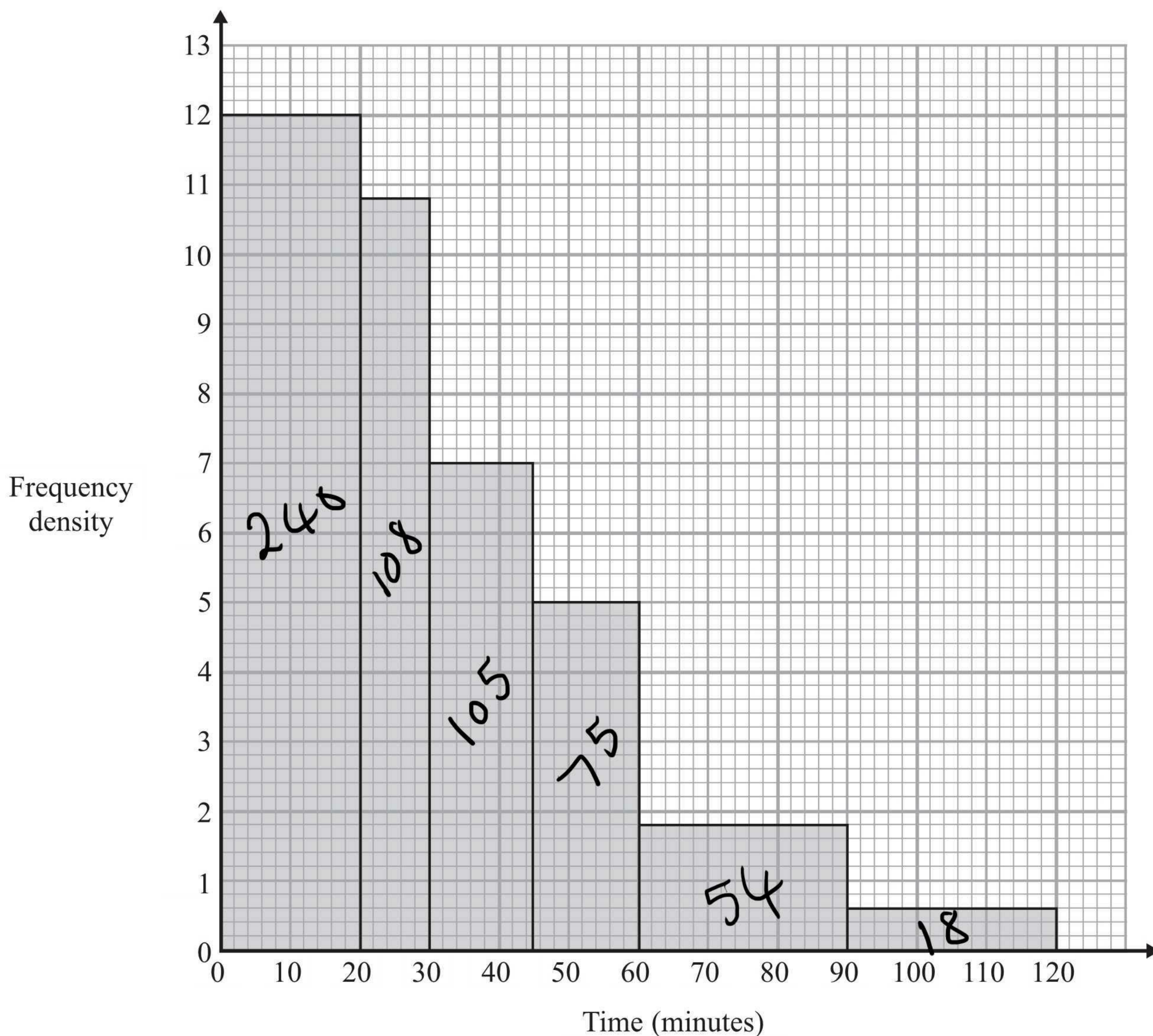

Work out the percentage of the passengers who had to wait for more than one hour.

$$\frac{54 + 18}{240 + 108 + 105 + 75 + 54 + 18} = 0.12$$

12%

(Total for Question 27 is 3 marks)



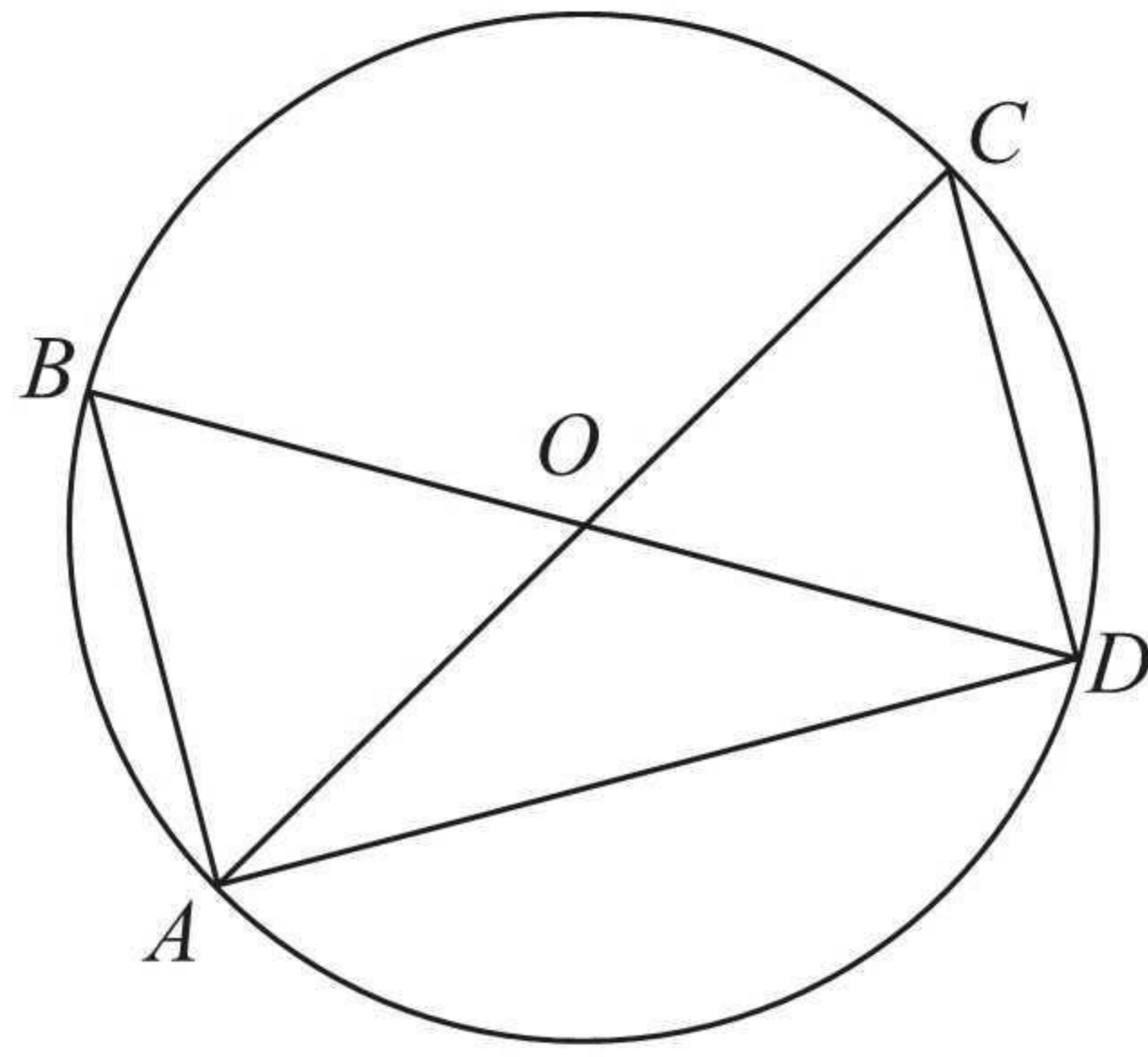

Diagram NOT
accurately drawn

AOC and BOD are diameters of a circle, centre O .

Prove that triangle ABD and triangle DCA are congruent.

$BD = DC$ both diameters
 AD is common to both triangles
 $\angle BAD$ and $\angle ADC$ are both 90°
 (angle in semi circle)

The two triangles are therefore
 congruent. RHS : they are
 right angled, with the hypotenuse
 and one other side equal.

(Total for Question 28 is 3 marks)

TOTAL FOR PAPER IS 100 MARKS

